

STANDARDOWE TYPY ZABUDOWY

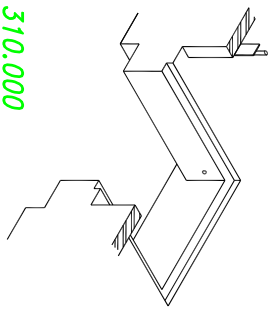

310.000

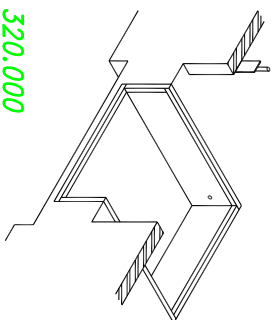

320.000

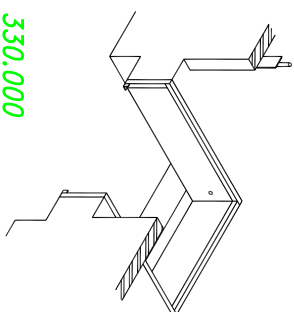

330.000

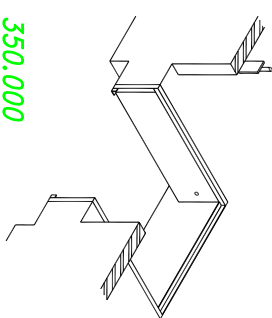

350.000

WARIANTY TRÓJNYCH ZABUDÓW

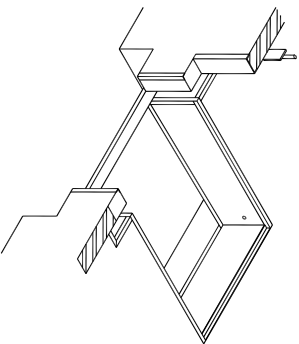

ZABUDOWA IZOLACYJNA ISO

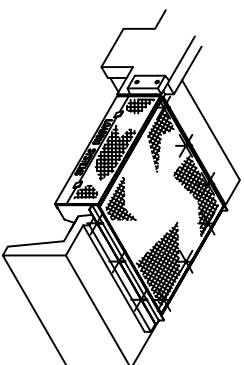

GOTOWY SYSTEM PRZELADUNKOWY

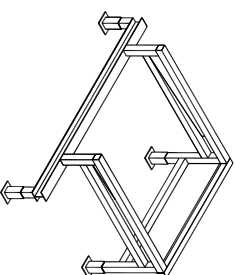

STALOWA RAMA KONSTRUKCYJNA
zewnętrzne stanowisko

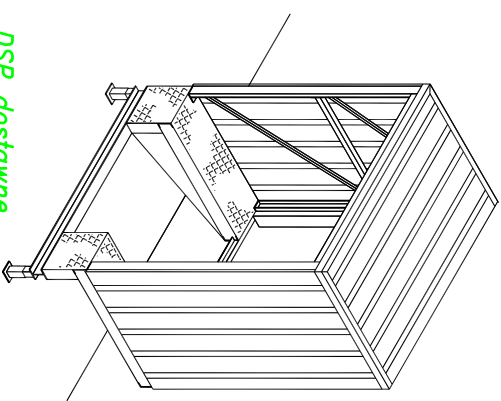

DSP dostawne
stanowisko przeladunkowe

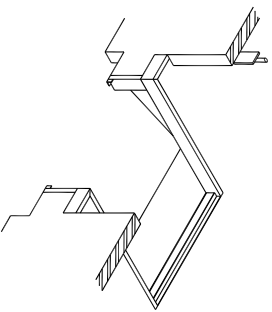

PREFABRYKAT BETONOWY



LOADING SYSTEMS

ZABUDOWY RAMP PRZELADUNKOWYCH